

GB743 SERIES INSTALLATION TOOLS

GB743

Stroke - .900" (22.86 mm)
 Hand held weight - 6.25 lbs. (2.83 kg)
 Entire tool weight - 6.25 lbs (2.83 kg)
 Pull load - 4,000 lbs. (17.79 kN)

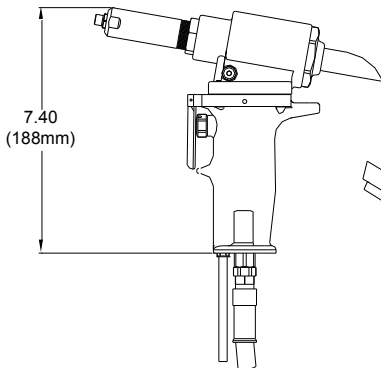
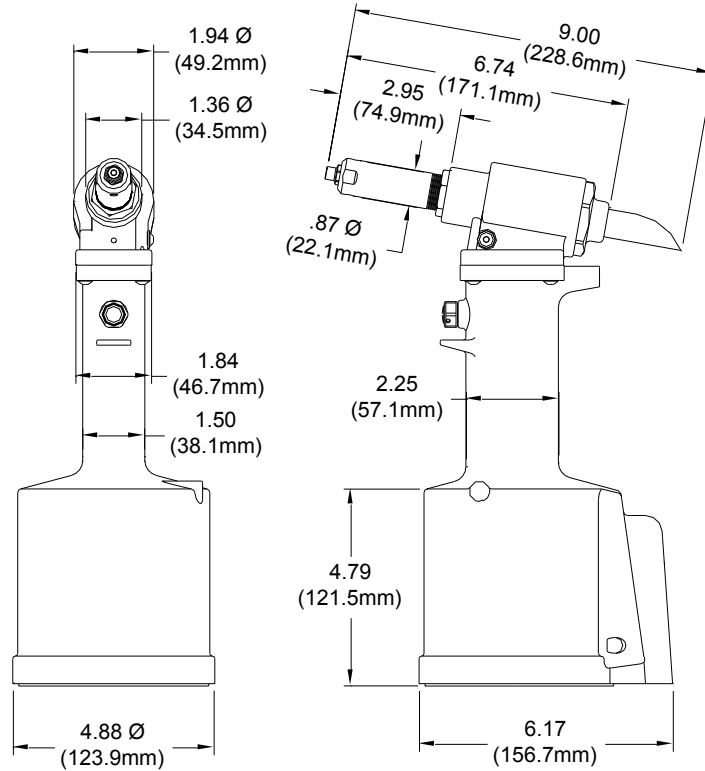

GB743SH

Stroke - .900" (22.86 mm)
 Hand held weight - 2.25 lbs. (1.02 kg)
 Entire tool weight - 7.25 lbs (3.29 kg)
 Pull load - 4,000 lbs. (17.79 kN)

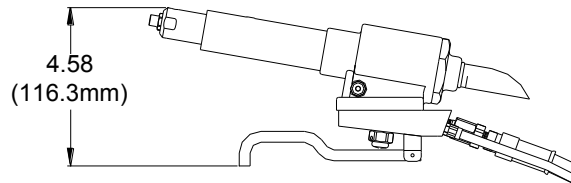

GB743SR

Stroke - .900" (22.86 mm)
 Hand held weight - 1.75 lbs. (.79 kg)
 Entire tool weight - 6.75 lbs (3.06 kg)
 Pull load - 4,000 lbs. (17.79 kN)

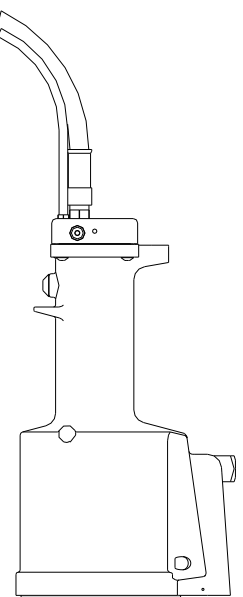
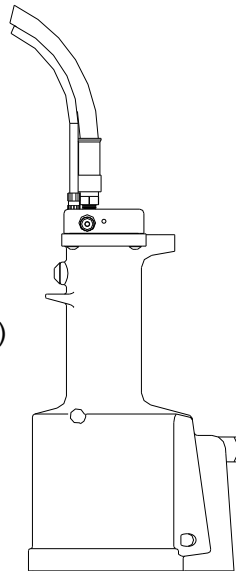

GAGE BILT

MADE IN U.S.A.

GAGE BILT Inc.

44766 Centre Court (586) 226-1500
 Clinton Twp. MI 48038 (586) 226-1505 Fax
 e-mail: solutions@gagebilt.com / www.gagebilt.com

DESCRIPTION

The GB743 series are pneumatic-hydraulic tools designed specifically for the efficient installation of a wide range of blind rivets. They can be operated in any position with one hand. They have a rated pull load of 4200 lbs. (18.68 kN) with 90 psi (6.2 bar) air pressure at the air inlet.

The GB743SH and GB743SR riveters offer a unique "split" system providing the operator with an ergonomic tool with reduced hand held weight, as shown below. The GB703SH comes with 8 feet of hose and the GB703SR comes with 3 feet of hose.

The GB743 series riveters operate on a wide range of air pressure, with 90 to 100 psi (6.2-6.9 bar) providing the maximum efficiency. At 90 psi (6.2 bar) air pressure, the GB743 series does not exceed 81.5 dB (A) and consumes 3 cfm at 20 cycles a minute.

Unless ordered rivet specific (I.E. GB743/4N), the GB743 series riveters are furnished with nose assembly 8N-743A-24 and spare nose tip 10204 to convert to 6N-743A-24. All other nose tips must be ordered separately. When ordering tool rivet specific, contact Gage Bilt for more information.

"VT" riveters are not furnished with the nose assemblies above and must be ordered for your specific rivet.

OPTIONS

The GB743 series riveters may be ordered with a vacuum system. Gage Bilt offers two varieties (see below)

Order GP743 series riveters rivet specific by adding the appropriate suffix (see selection chart).



GB743 SERIES SELECTION CHART



RIVET	DIA.	NOSE ASSEMBLY	NOSE TIP	JAW	FOLLOWER	DESIGNATION
AVEX® (1624 PROTRUDING HEAD)	3/16	AV6-743-24 ₁	10248-7	30824	48808	AV6
AVEX (1624 COUNTERSUNK HEAD)	3/16	6C-743-24 ₁	10248-8	30824	48808	6C
BULB-TITE® (STRUCTURAL) RIVET	3/16	BT06-743-24 ₁	12282-1	30824	48808	BT06
	1/4	BT08-743-24 ₁	10391	30824	48808	BT08
	9/32	BT09-743-24 ₁	10289	30824	40901	BT09
KLAMP-TITE® (STRUCTURAL) RIVET	3/16	6KT-743-24 ₁	10263	30824	48808	6KT
	1/4	8KT-743-24 ₁	10262	30824	48808	8KT
MILLIMETER SEAL PLUG	4MM	5N-743-24 ₁	10203	30824	48808	5N
	5MM	6N-743-24 ₁	10204	30824	48808	6N
MONOBOLT® RIVET	3/16	MB06-734A-20 ₂	-	-	-	MB06
	1/4	MB08-734A-20 ₂	-	-	-	MB08
OPEN END NAIL RIVET	3/32	3N-703-18 ₂	-	-	-	3N
	1/8	4N-703-18 ₂	-	-	-	4N
	5/32	5N-703-18 ₂	-	-	-	5N
	3/16	6N-743-24 ₁	10204	30824	48808	6N
	1/4	8N-743-24 ₁	10211	30824	48808	8N
CLOSED END NAIL RIVET (ALUMINUM MANDREL)	3/32	3N-703-18 ₂	-	-	-	3N
	1/8	4CEA-703-18 ₂	-	-	-	4CEA
	5/32	5CEA-703-18 ₂	-	-	-	5CEA
	3/16	6CEA-743-24 ₁	13473	30824	48808	6CEA
CLOSED END NAIL RIVET (STEEL MANDREL)	3/32	3N-703-18 ₂	-	-	-	3N
	1/8	4CES-703-18 ₂	-	-	-	4CES
	5/32	5CES-703-18 ₂	-	-	-	5CES
	3/16	6CES-743-24 ₁	13477	30824	48808	6CES
1/4	8CES-743-24 ₁	13469	30824	48808	8CES	
PLASTIC SPLIT RIVET	3/32	3P-703-18 ₂	-	-	-	3P
	1/8	4P-703-18 ₂	-	-	-	4P
	5/32	5P-703-18 ₂	-	-	-	5P
	3/16	6P-743-24 ₁	10167	30824	48808	6P
1/4	8P-743-24 ₁	10166	30824	48808	8P	
T RIVET®	3/16	6T-743-24 ₁	10209	30824	48808	6T
	1/4	8T-743-24 ₁	10286	30824	48808	8T
TLR® RIVET	1/4	8TLR-743-24 ₁	10246	30824	48808	8TLR
COUNTERSUNK HEAD						
SERRATED STEM STRUCTURAL RIVET	3/16	C6-734A-20 ₂	-	-	-	C6
	1/4	C8-734A-20 ₂	-	-	-	C8
PROTRUDING HEAD						
SERRATED STEM STRUCTURAL RIVET	3/16	PH6-734A-20 ₂	-	-	-	PH6
	1/4	PH8-734A-20 ₂	-	-	-	PH8

AVEX®, KLAMP-TITE®, TLR® AND MONOBOLT® ARE REGISTERED TRADEMARKS OF AVDEL UK LIMITED. T RIVET® IS A REGISTERED TRADEMARK OF CHERRY AEROSPACE FASTENERS. BULB-TITE® IS A REGISTERED TRADEMARK OF GESIPA FASTENERS USA, INC.

1) YOU CAN CHANGE THE 743-24 NOSE ASSEMBLY (INCLUDED WITH TOOL) TO INSTALL OTHER FASTENERS BY PURCHASING NOSE TIP SHOWN AND USING APPROPRIATE FOLLOWER SHOWN.

2) NOSE ASSEMBLIES WITH A 703-18 AND 734A-20 DESIGNATION, I.E. 5P-703-18, MUST BE ORDERED AS COMPLETE NOSE ASSEMBLY.

NOTE: THE LAST 2 DIGITS OF THE NOSE ASSEMBLY REPRESENTS THE LENGTH THE NOSE EXTENDS FROM THE TOOL. I.E. -20 = 2.0 INCHES

REV. 10/14

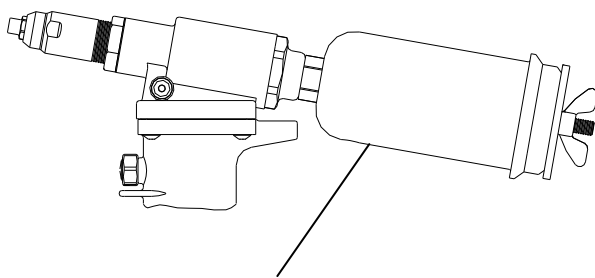

"V" DESIGNATION = PINTAIL COLLECTOR BOTTLE

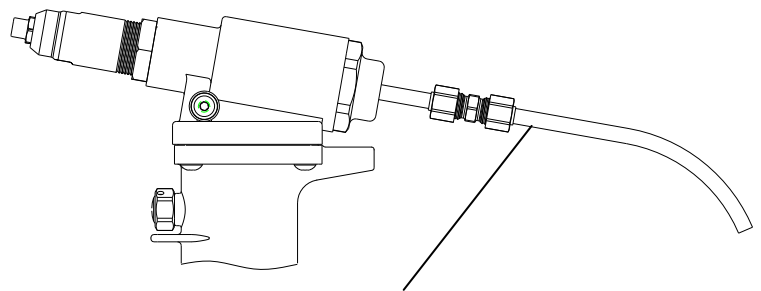

"VT" DESIGNATION = PINTAIL EVACUATION TUBE
(TOOL MUST BE ORDERED FOR YOUR SPECIFIC RIVET. CONTACT GAGE BILT INC. FOR SPECIFIC APPLICATIONS.)

HOW TO ORDER GB743 SERIES TOOLS

